

**thinkk**

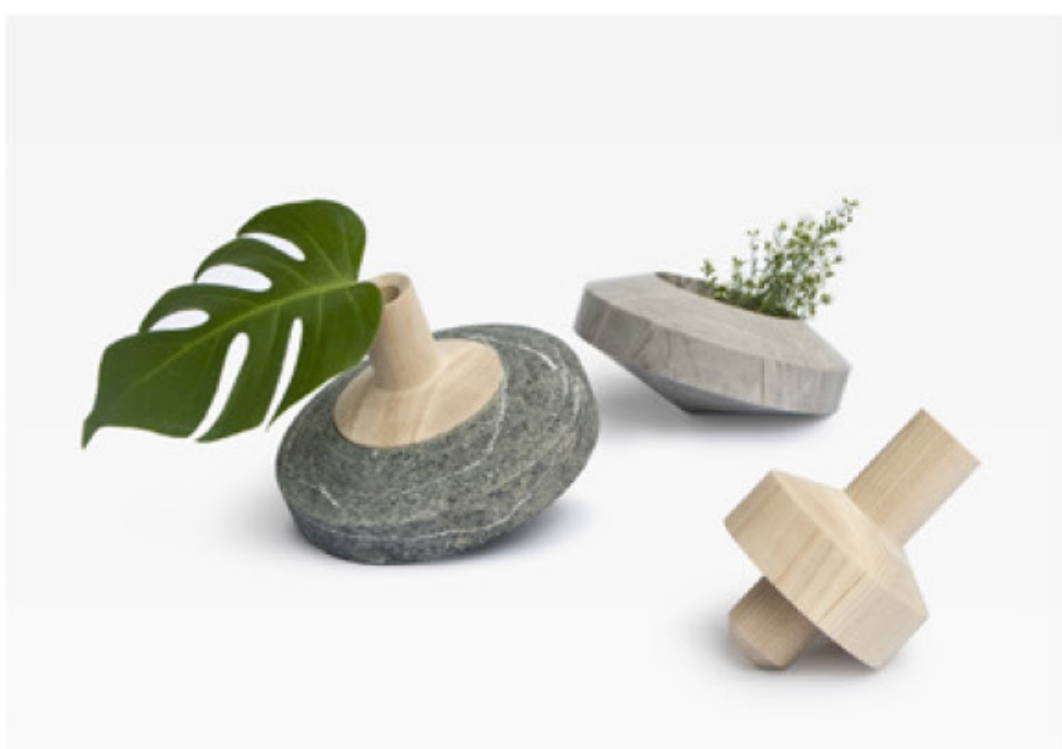

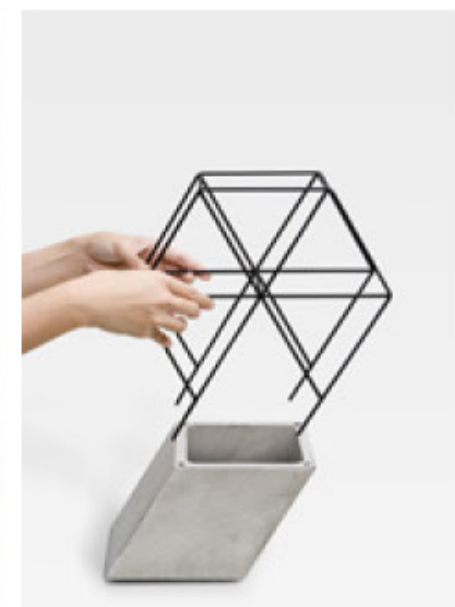

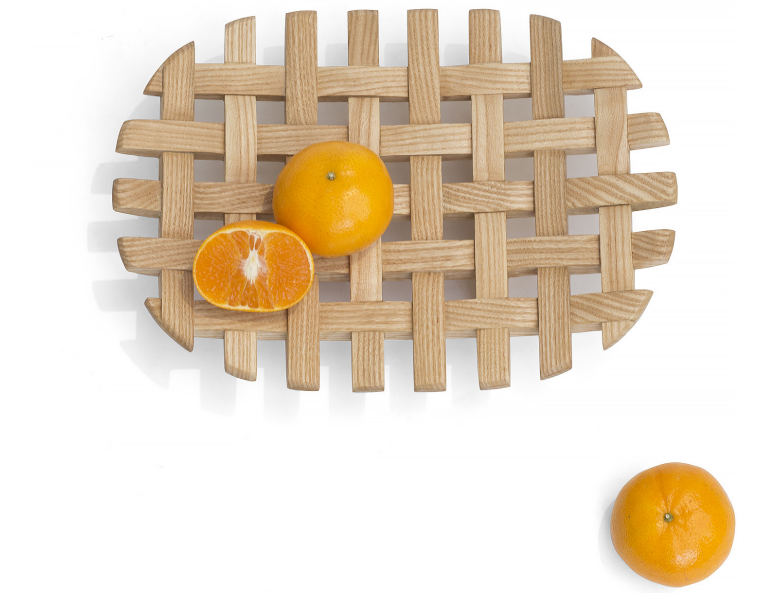
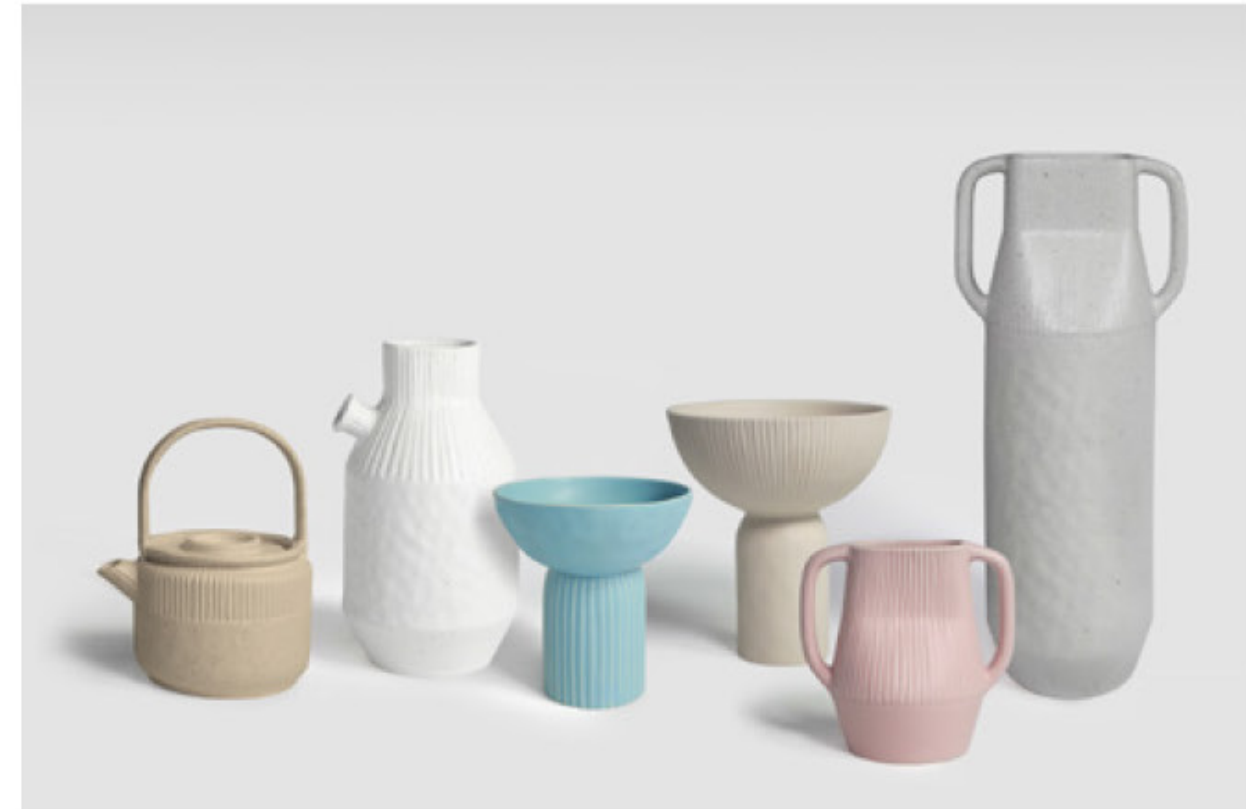
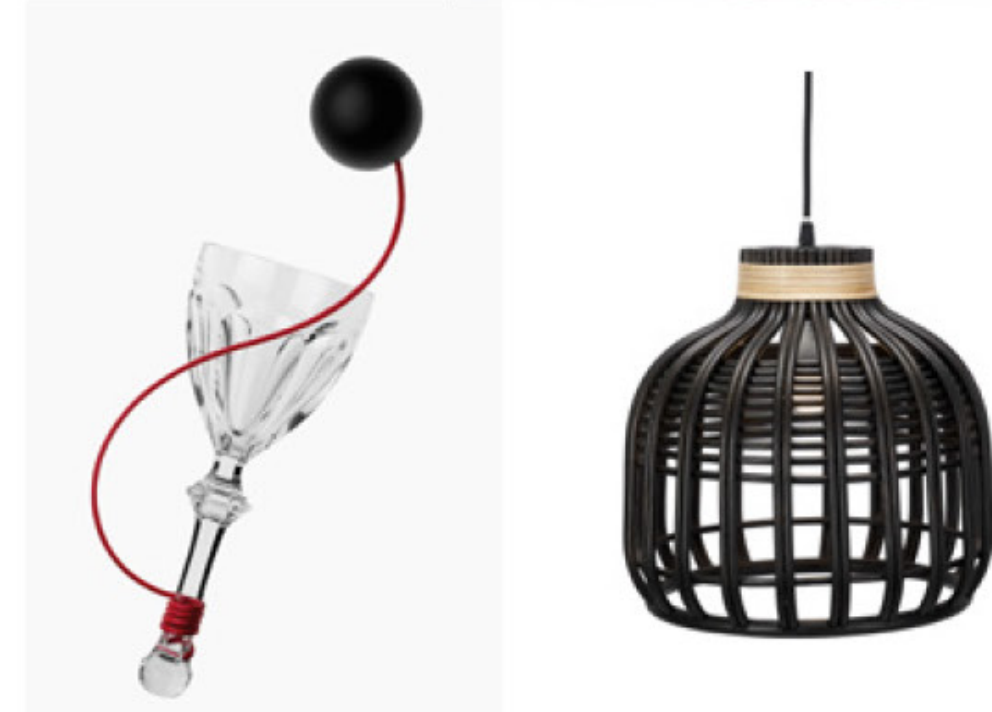

# UNORTHODOX EXPERIMENT

# ขั้นตอนจากวัตถุดิบตั้งต้นไปสู่วัสดุสำหรับผู้บริโภค

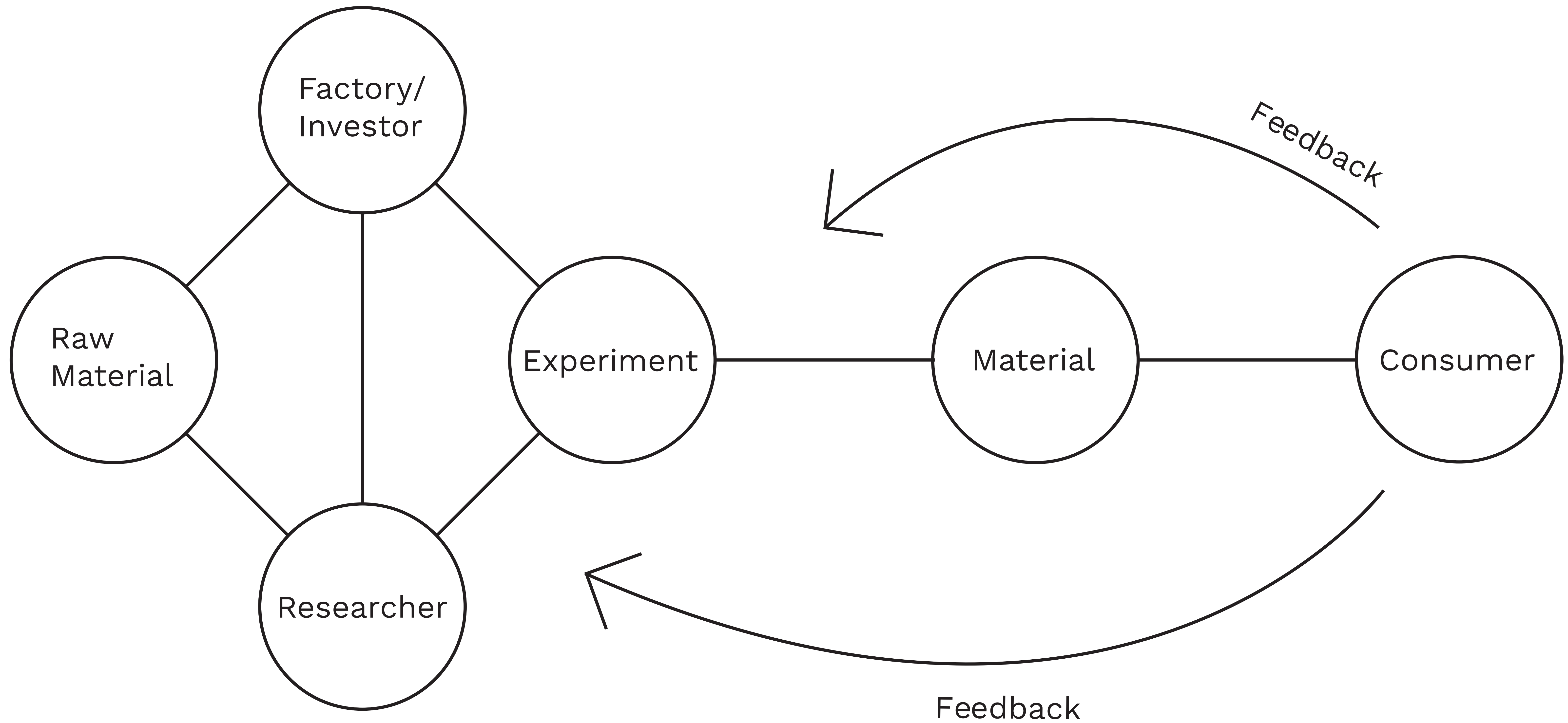



# ขั้นตอนจากวัตถุดิบตั้งต้นไปสู่วัสดุสำหรับผู้บริโภค + บทบาทของนักออกแบบ

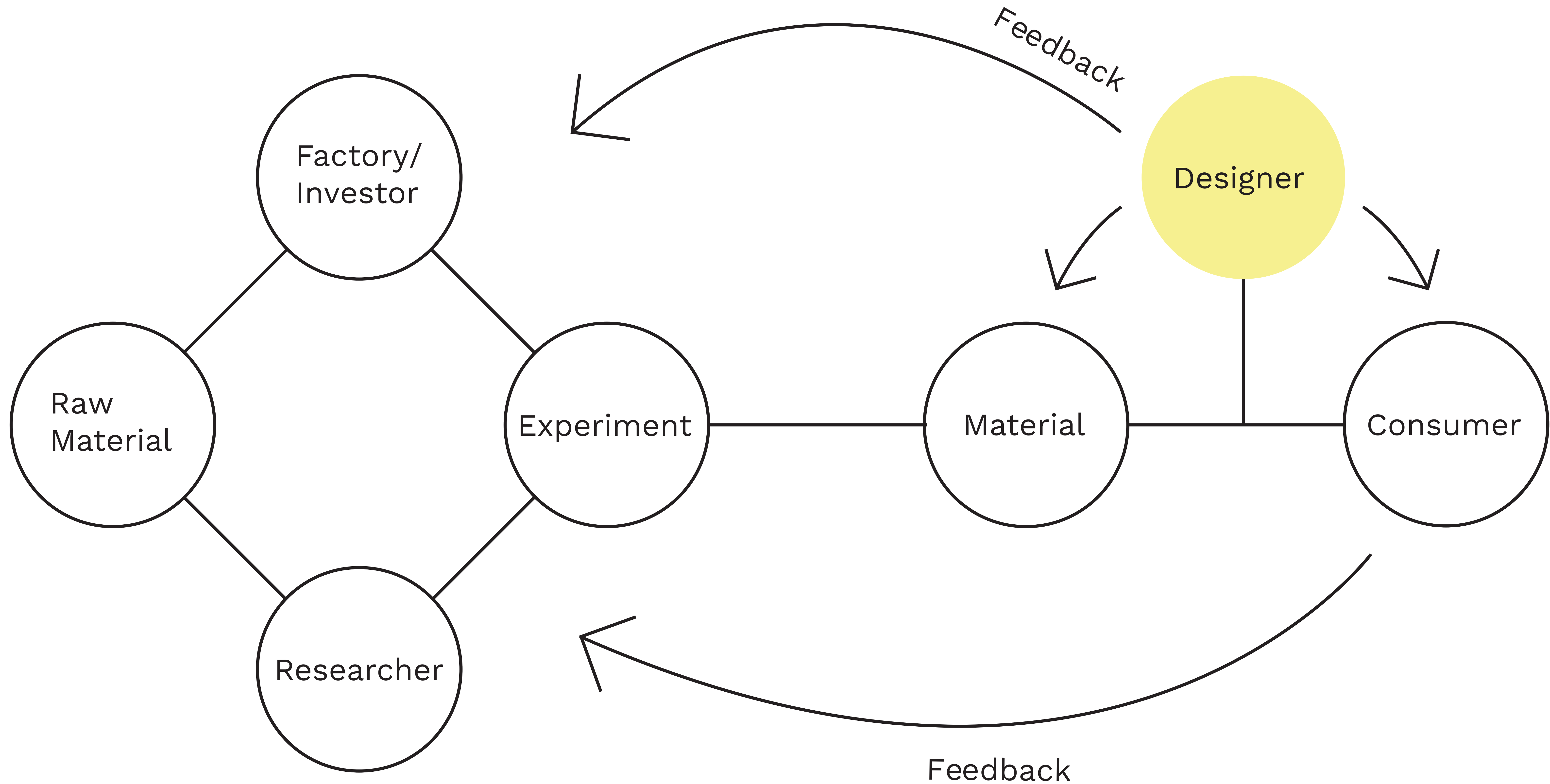



ขั้นตอนจากวัตถุดิบตั้งต้นไปสู่วัสดุสำหรับผู้บริโภค ที่นักออกแบบมีศักยภาพที่จะเริ่มทำได้

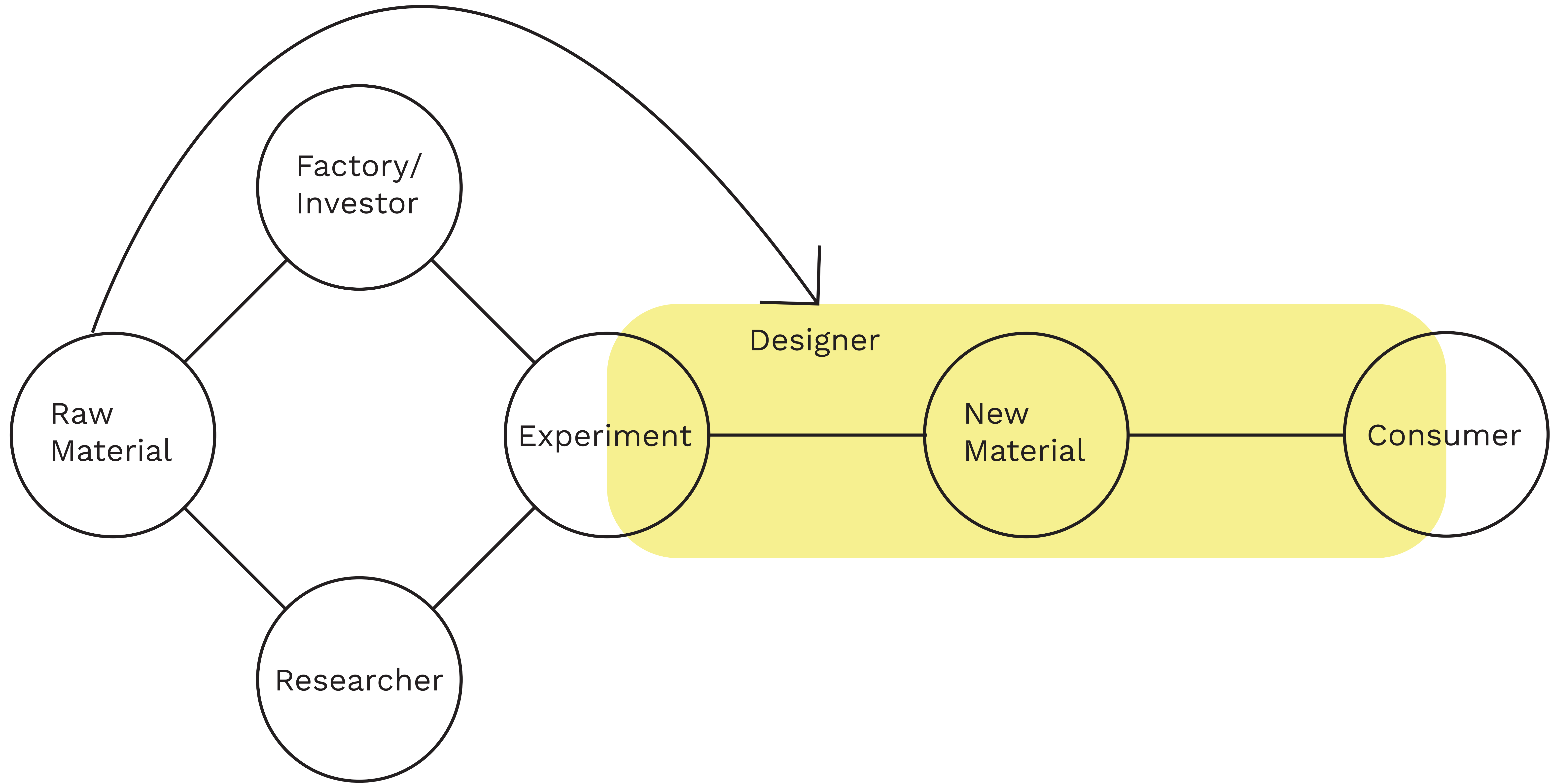



ขั้นตอนจากวัตถุดิบตั้งต้นไปสู่วัสดุสำหรับผู้บริโภค ที่นักออกแบบมีส่วนร่วมในทุกๆขั้นตอน

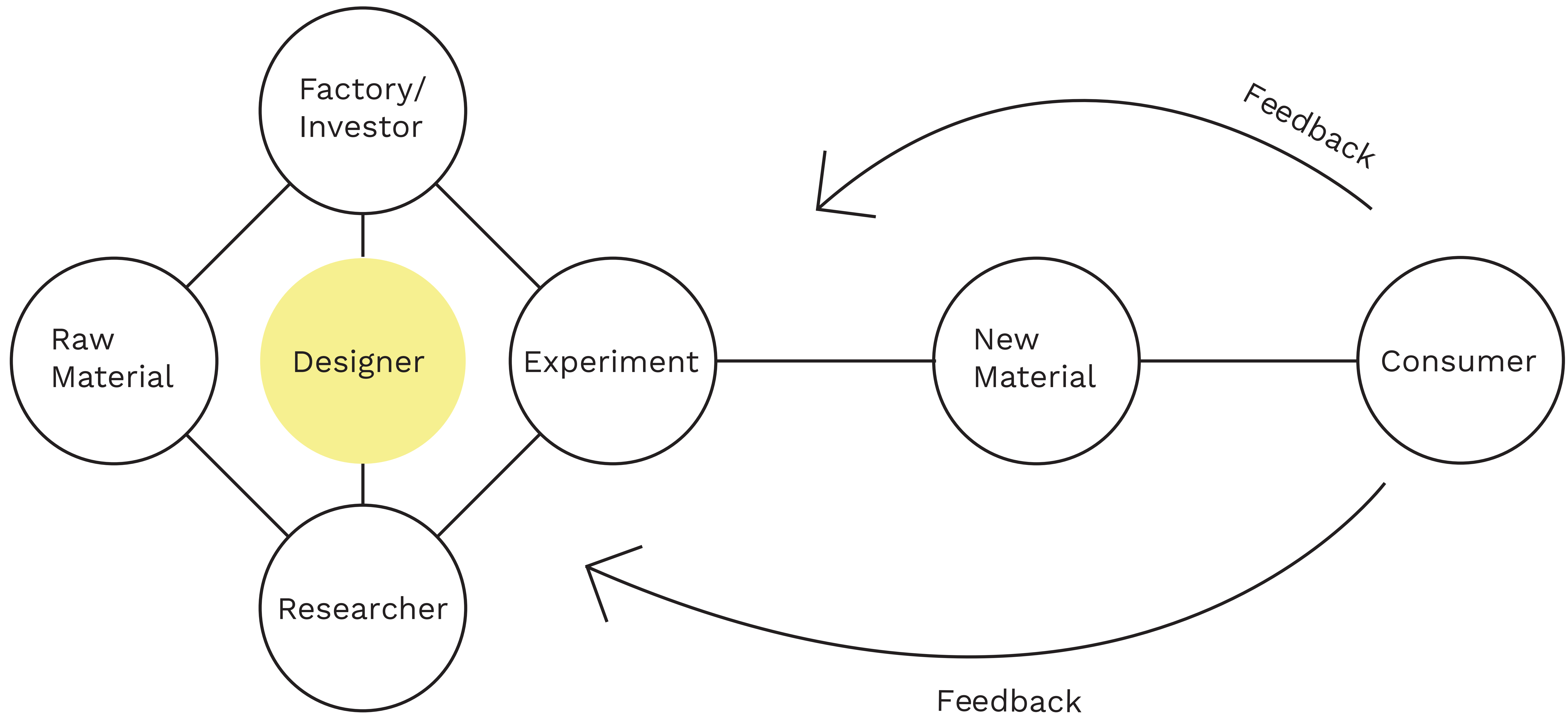



**CITY MATERIALS**











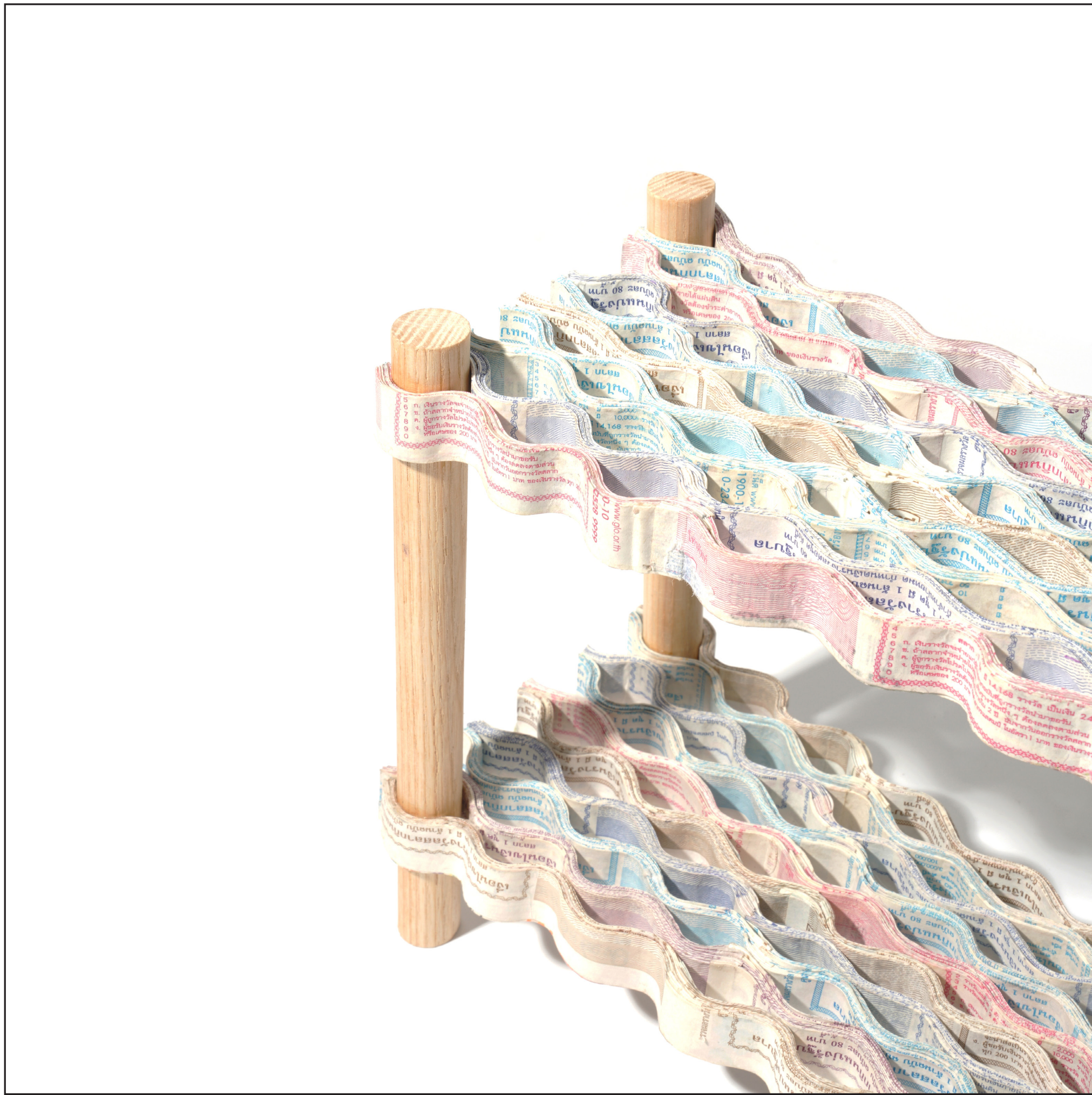



แผนผังแสดงวัดไทยและศาลเจ้าใน  
เขตสัมพันธวงศ์ มีศาสนสถานที่  
ใช้รูปต่อตารางเมตรเยอะที่สุด

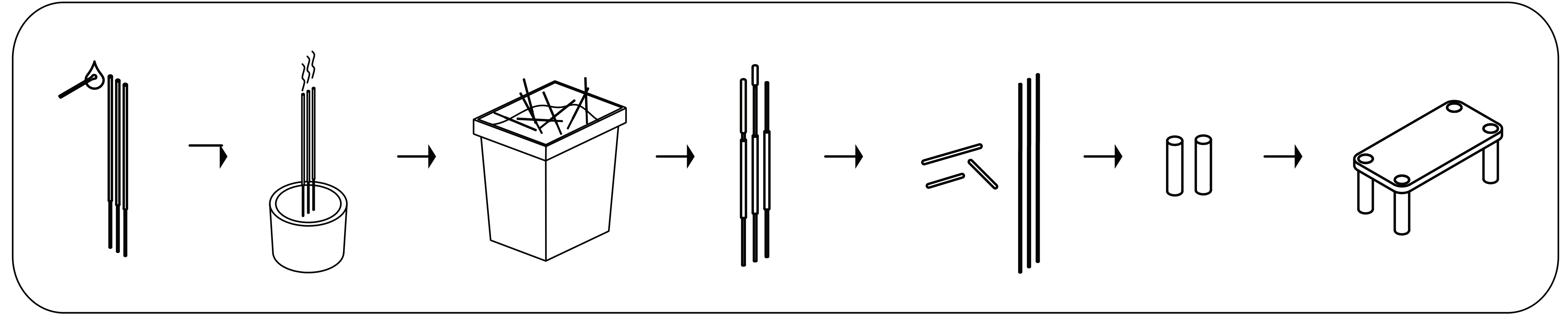
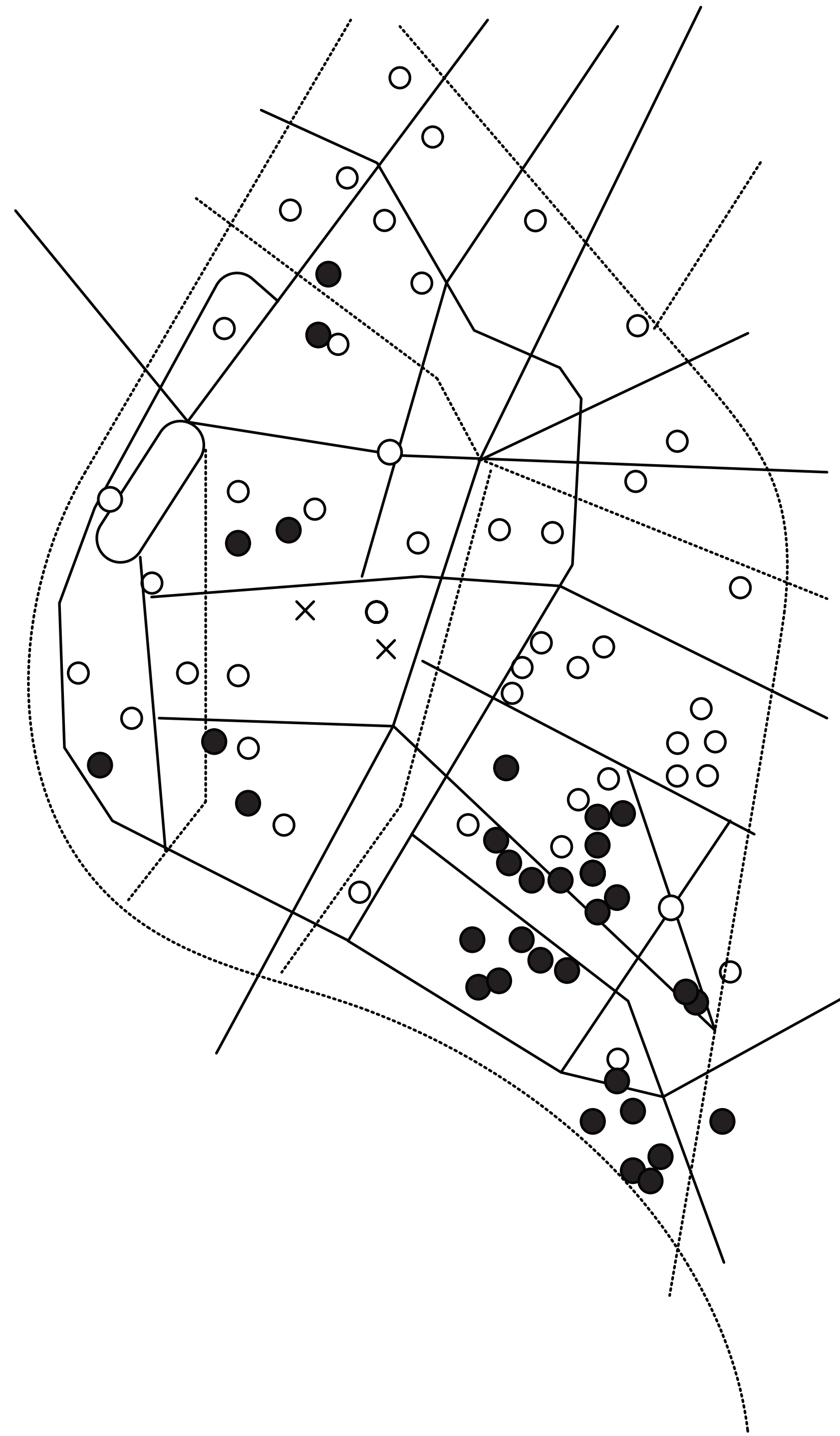

- Buddhist temple วัดไทย
- Chinese temple and Shrine วัดจีนและศาลเจ้า
- × Hindu temple ศาสนสถานของศาสนาฮินดู

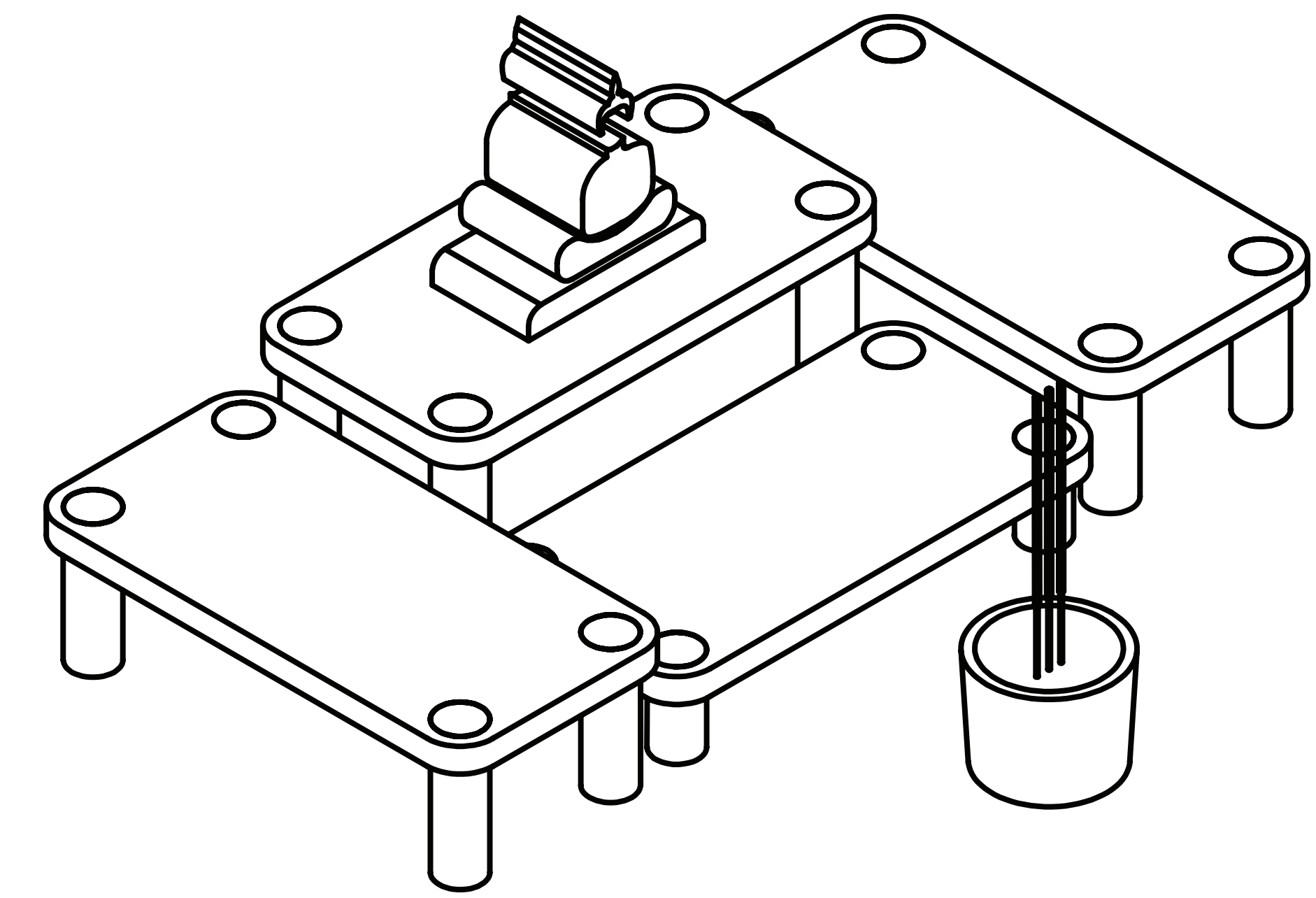



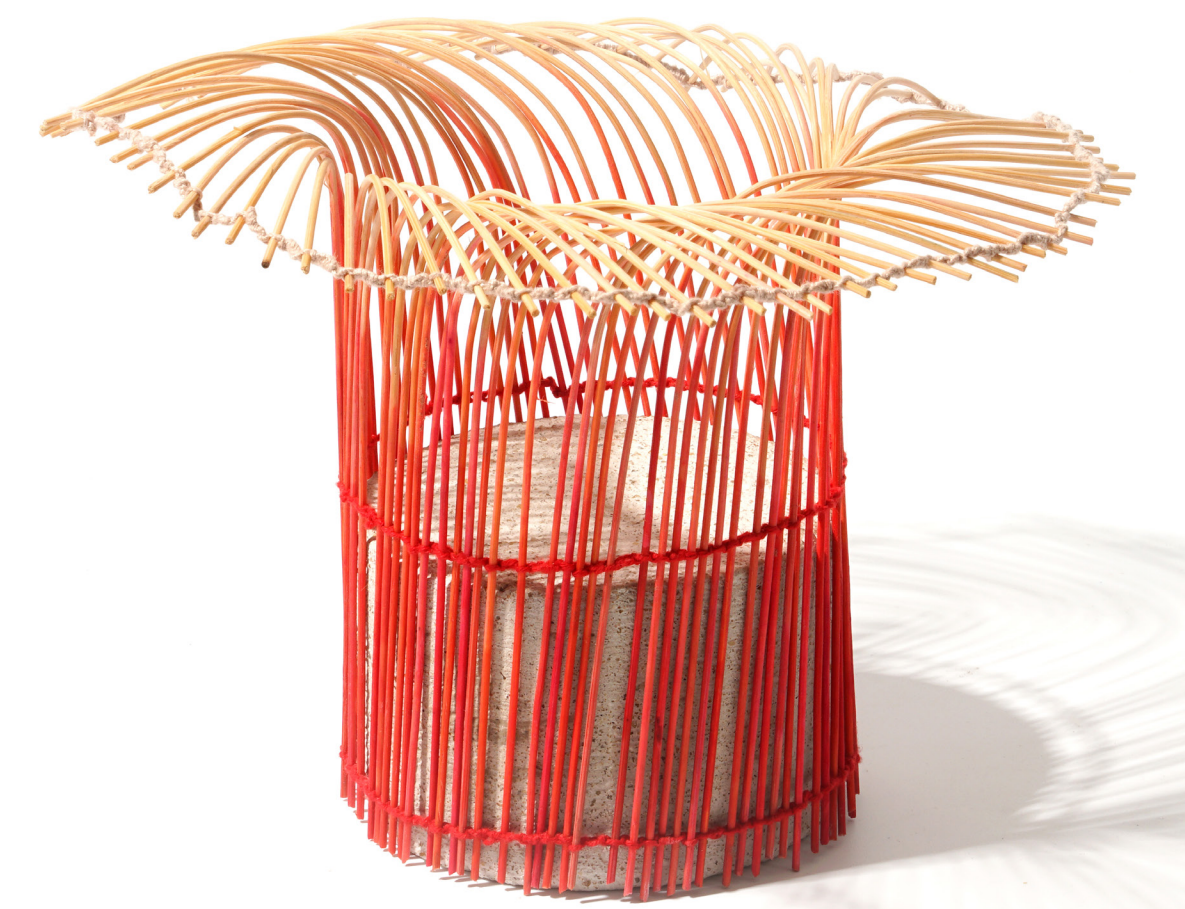



**DEWA**



**DEWA**  
DEsign from Waste Agriculture

**DITP**  
กรมส่งเสริมการค้าระหว่างประเทศ  
กระทรวงพาณิชย์

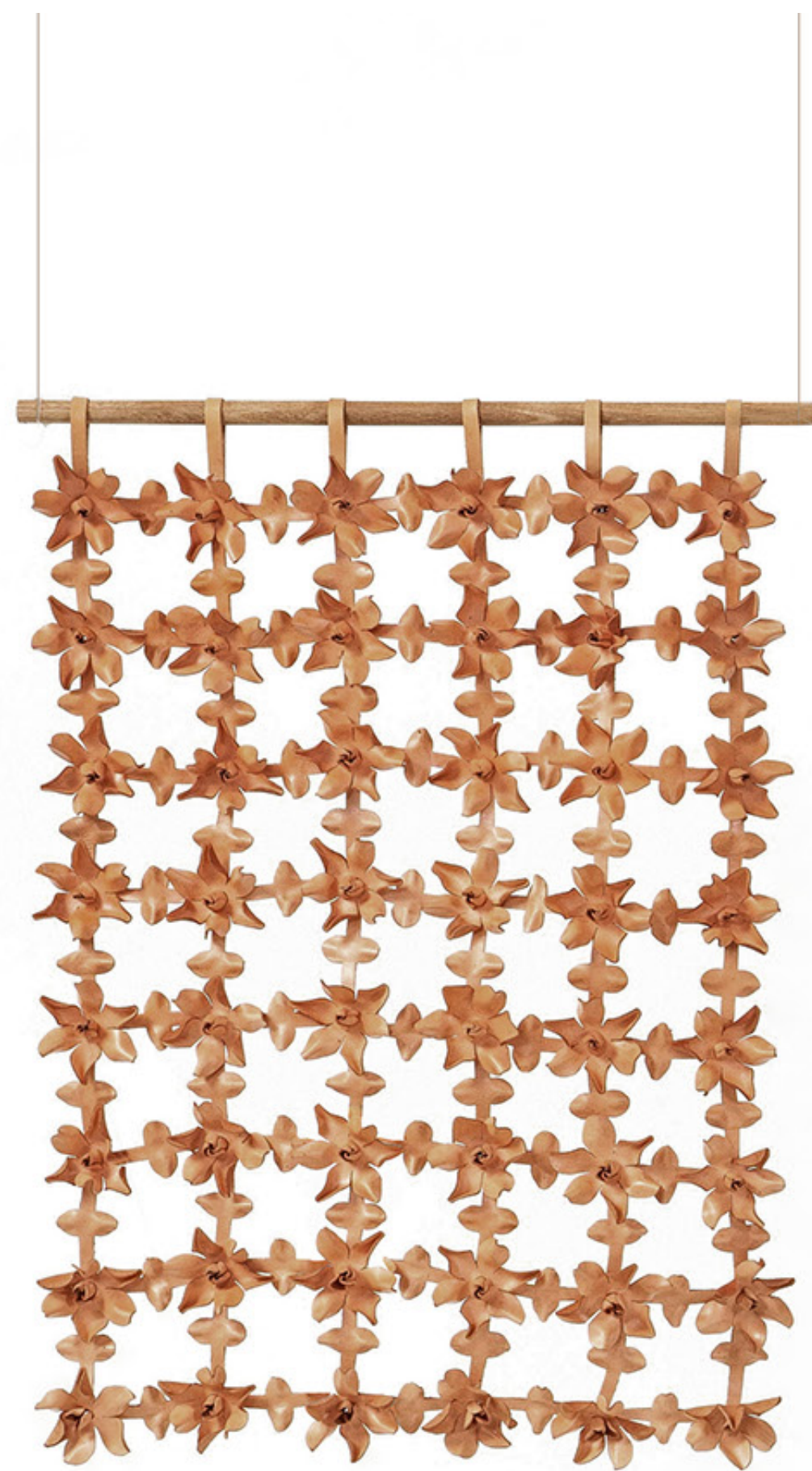



**DEWA**  
DEsign from Waste Agriculture

**DITP**  
กรมส่งเสริมการค้าระหว่างประเทศ  
กระทรวงพาณิชย์

























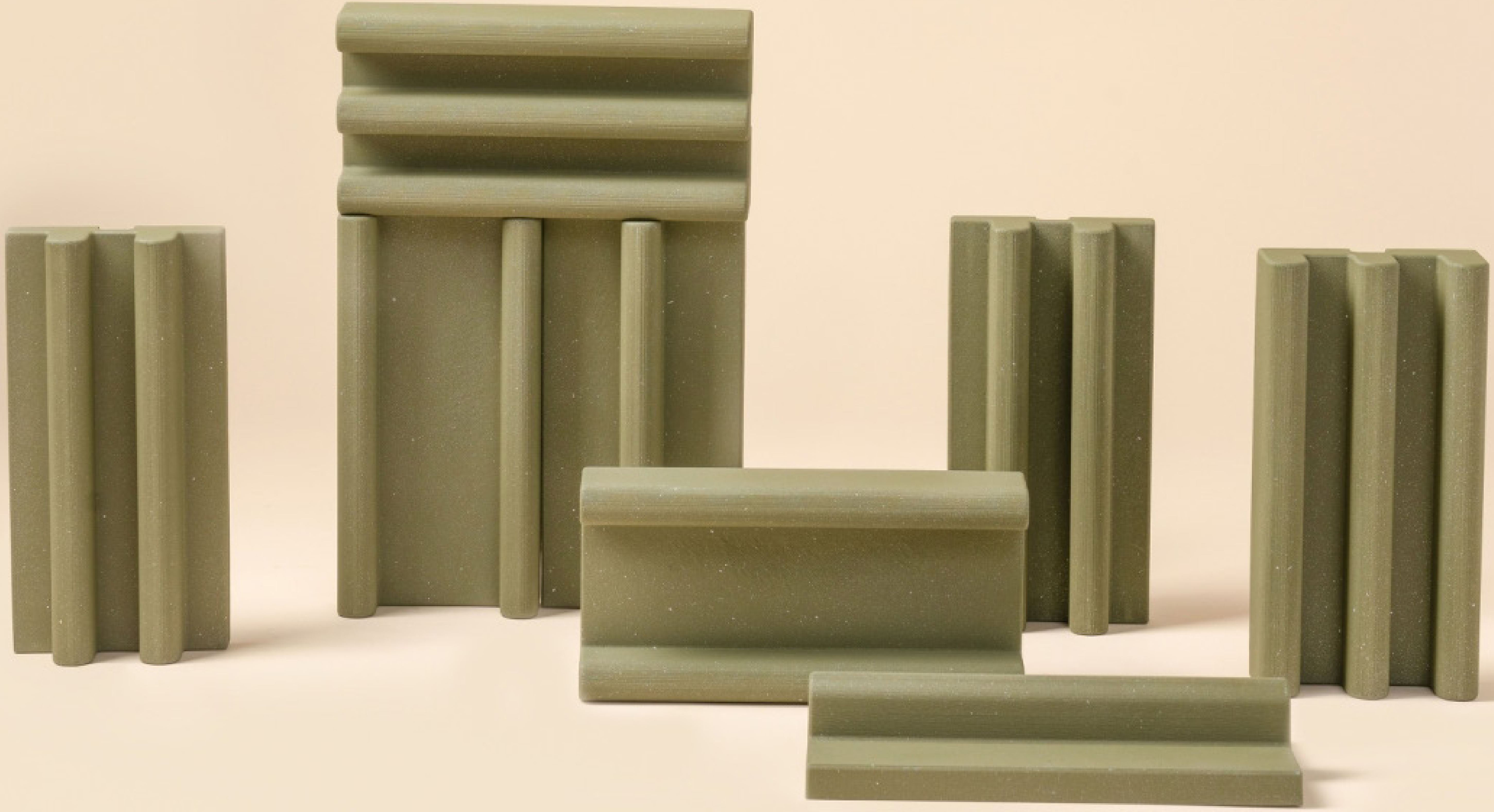







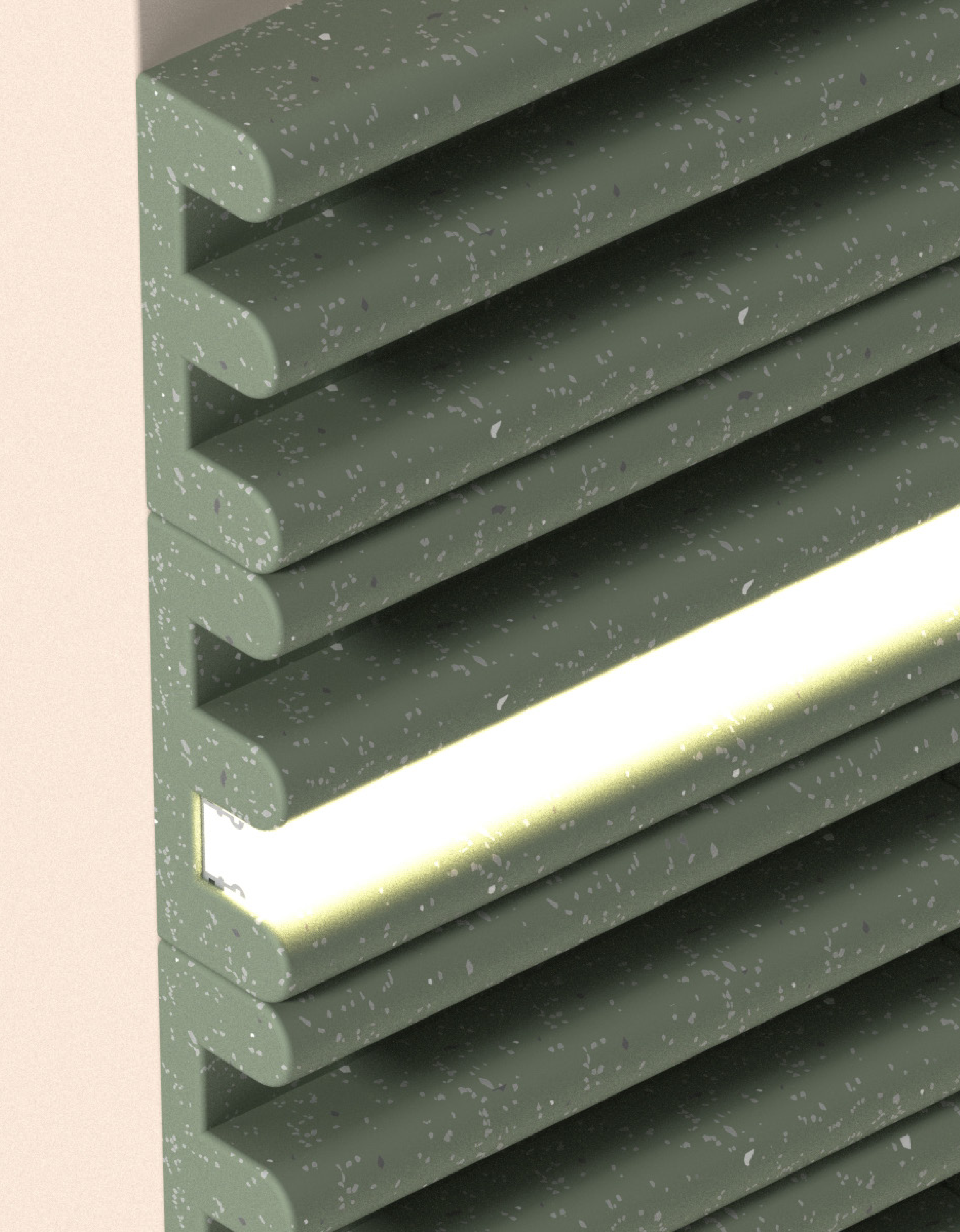
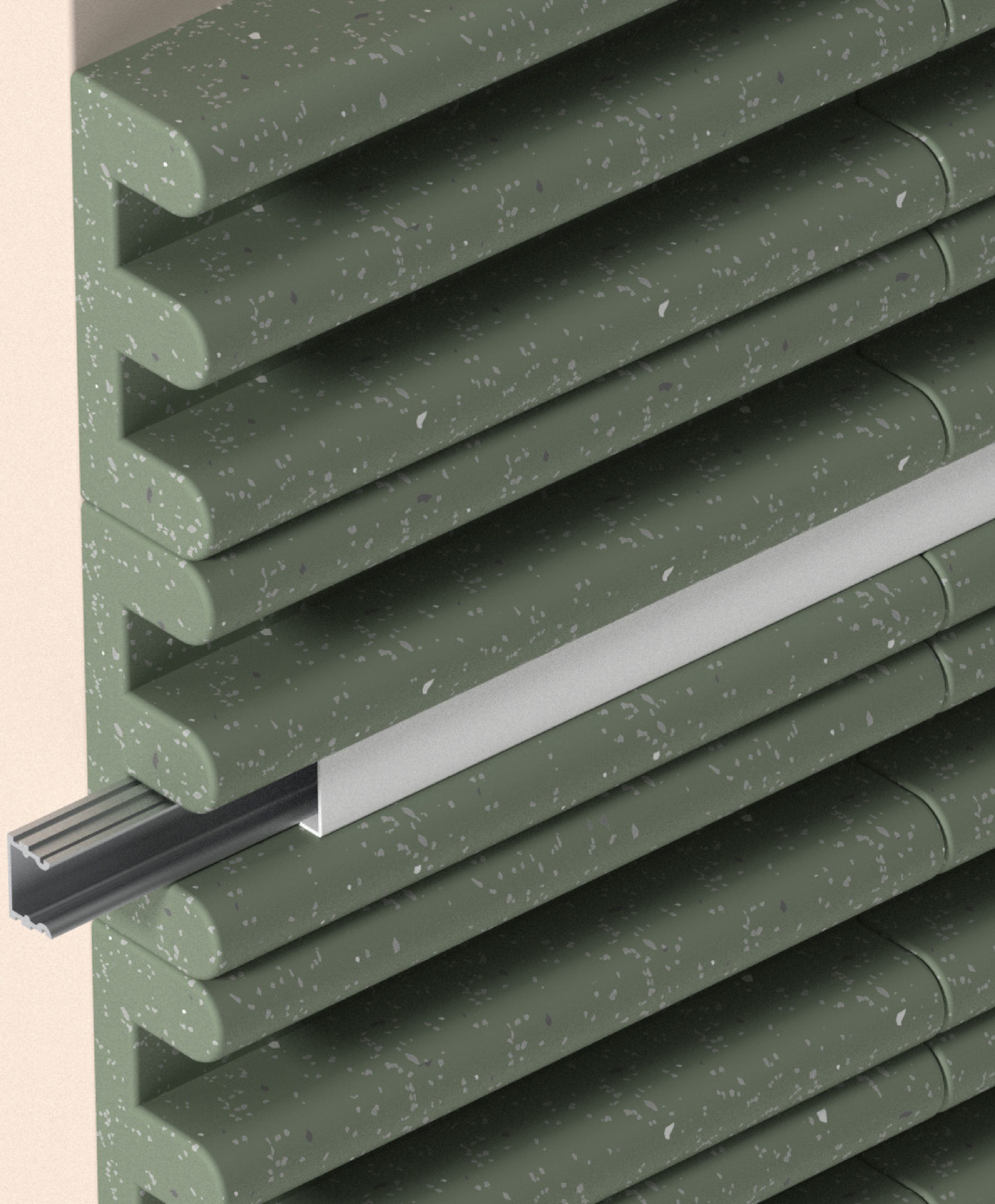



**UPCYCLING  
UPSTYLING**



**LAWANVISUT**



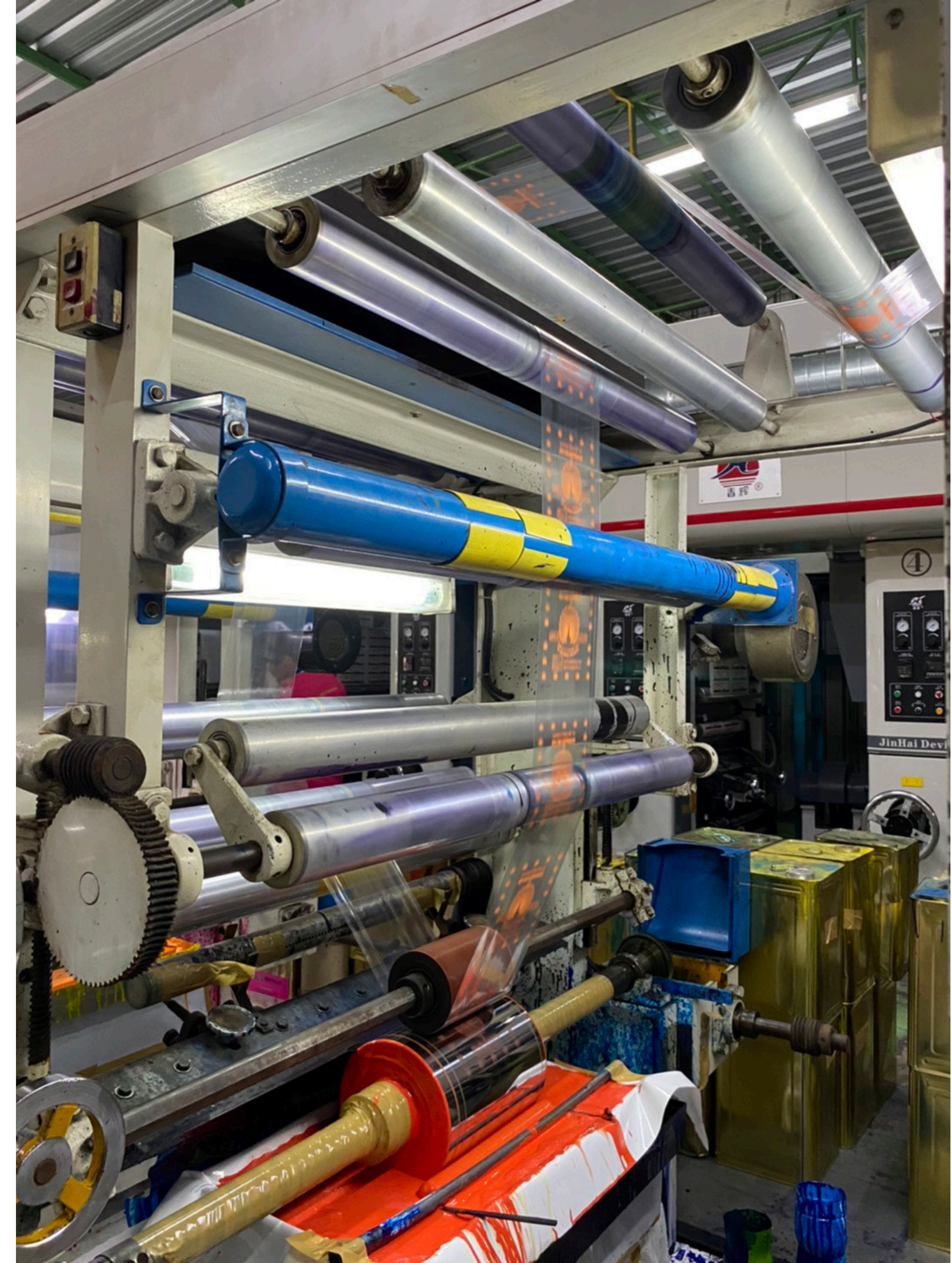















**SANGROONG**







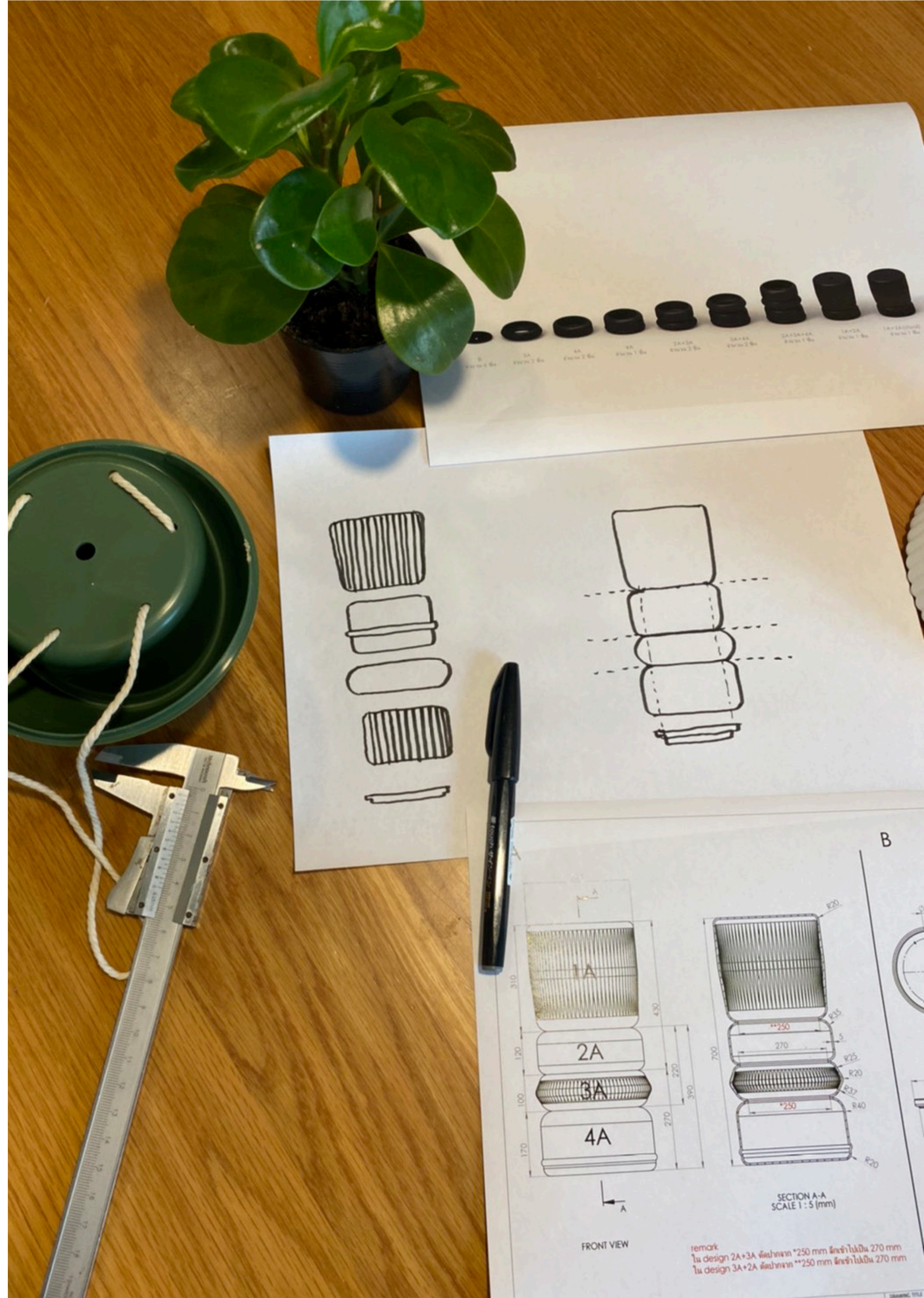
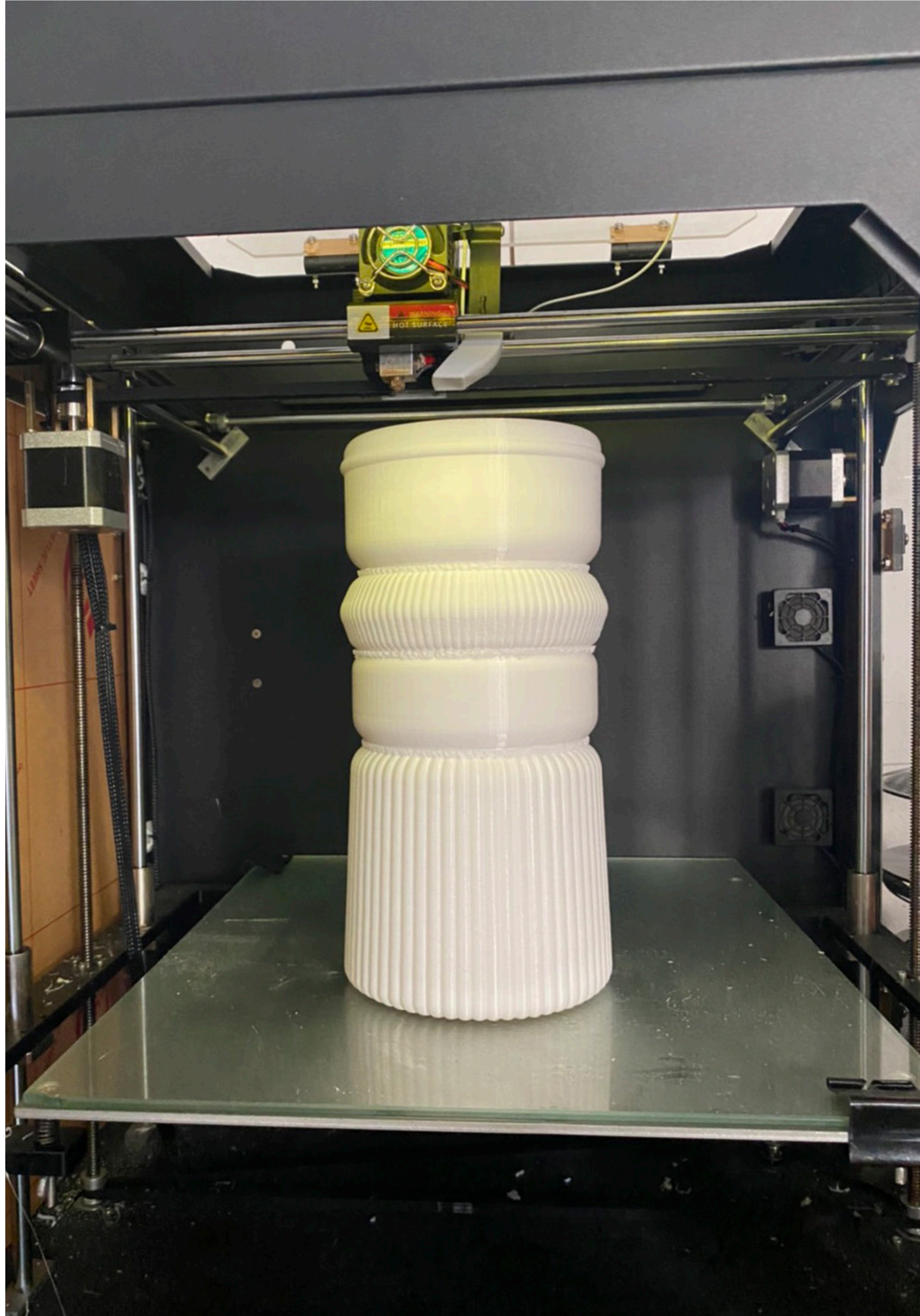







**thinkk**